

Color all the things with a /ph/ sound. Find the hidden letters /ph/ in the picture.

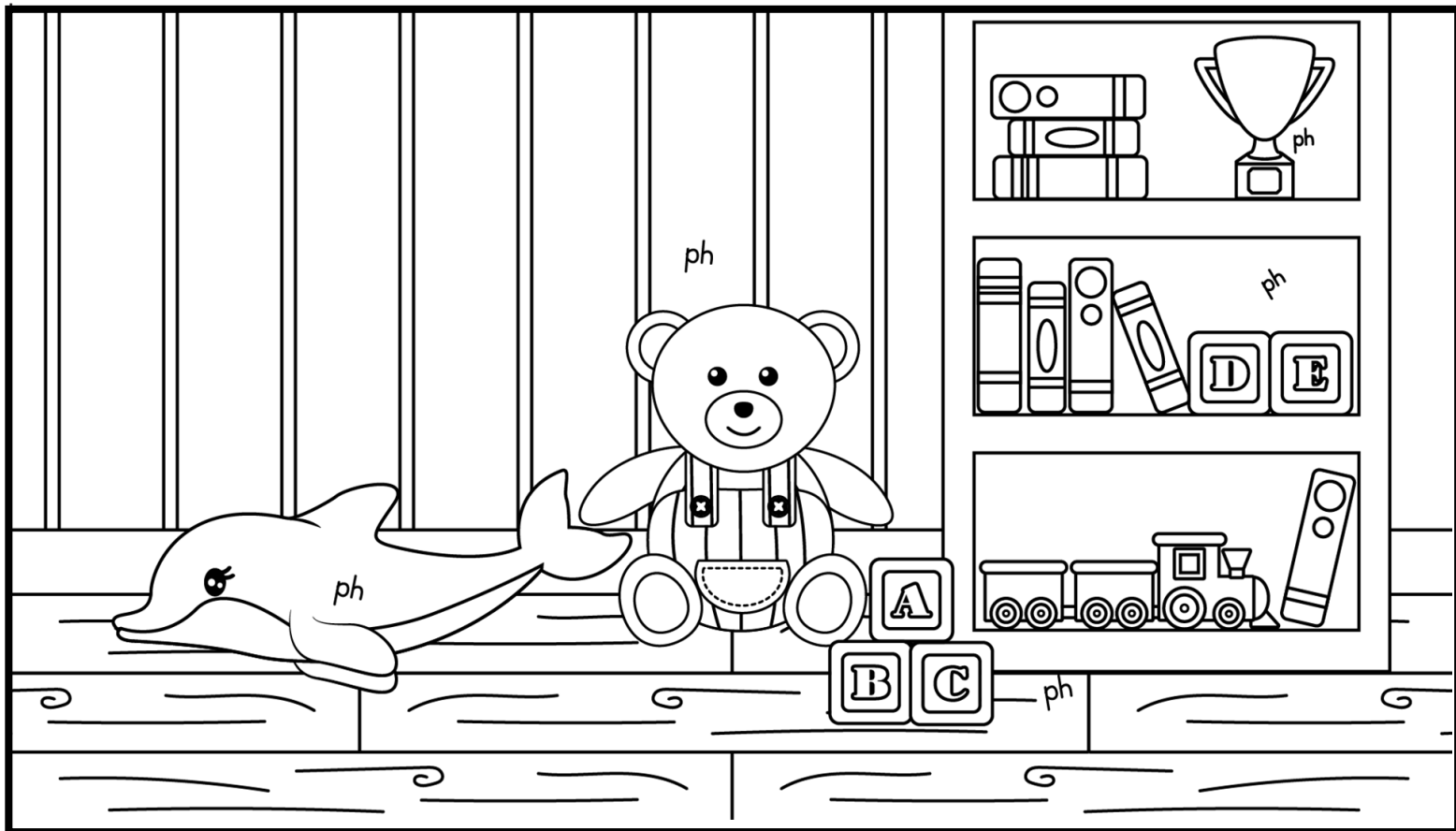

Trace /ph/ words below. Circle all the letter ph's you can find.

ph bh hh ph **ph** dolphin ph ch
 gh gh eh ph **ph** trophy gh ch **ph** ph ch ph
 ph ch ph ch ph ch fh gh **ph** hh
 ph gh ph gh **ph** ch **ch** ph ph **ph** ch
 ch **ph** fh **ph** ph **alphabet** ch

Phonics

Garden

Name _____

Color all the things with a /ph/ sound. Find the hidden letters.

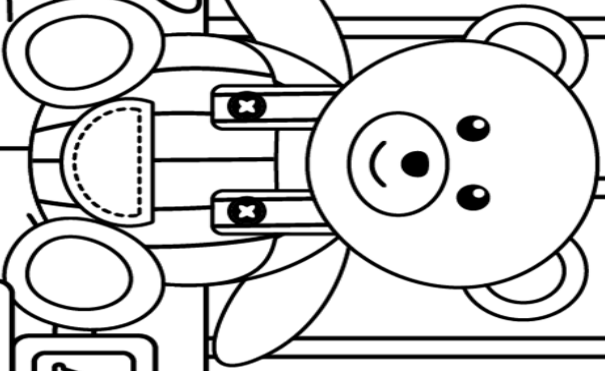

ph

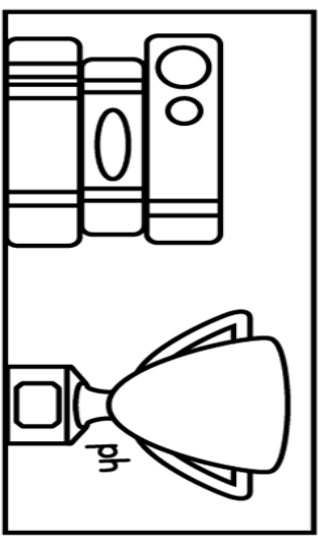
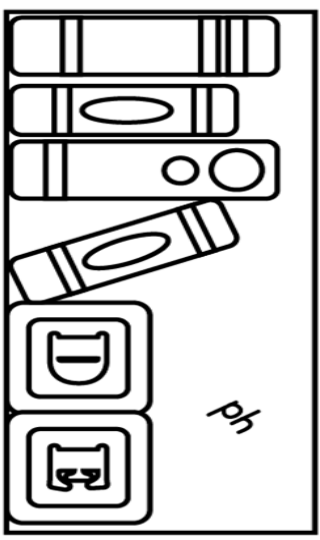
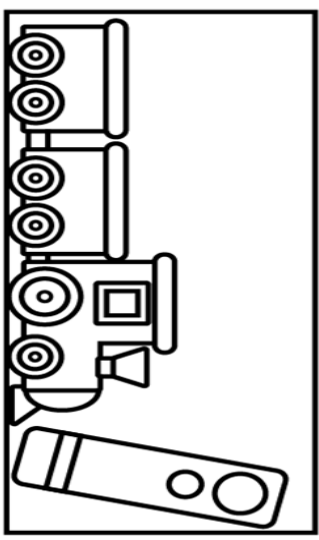

Color all the things with a /ph/ sound. Find the hidden letters /ph/ in the picture.

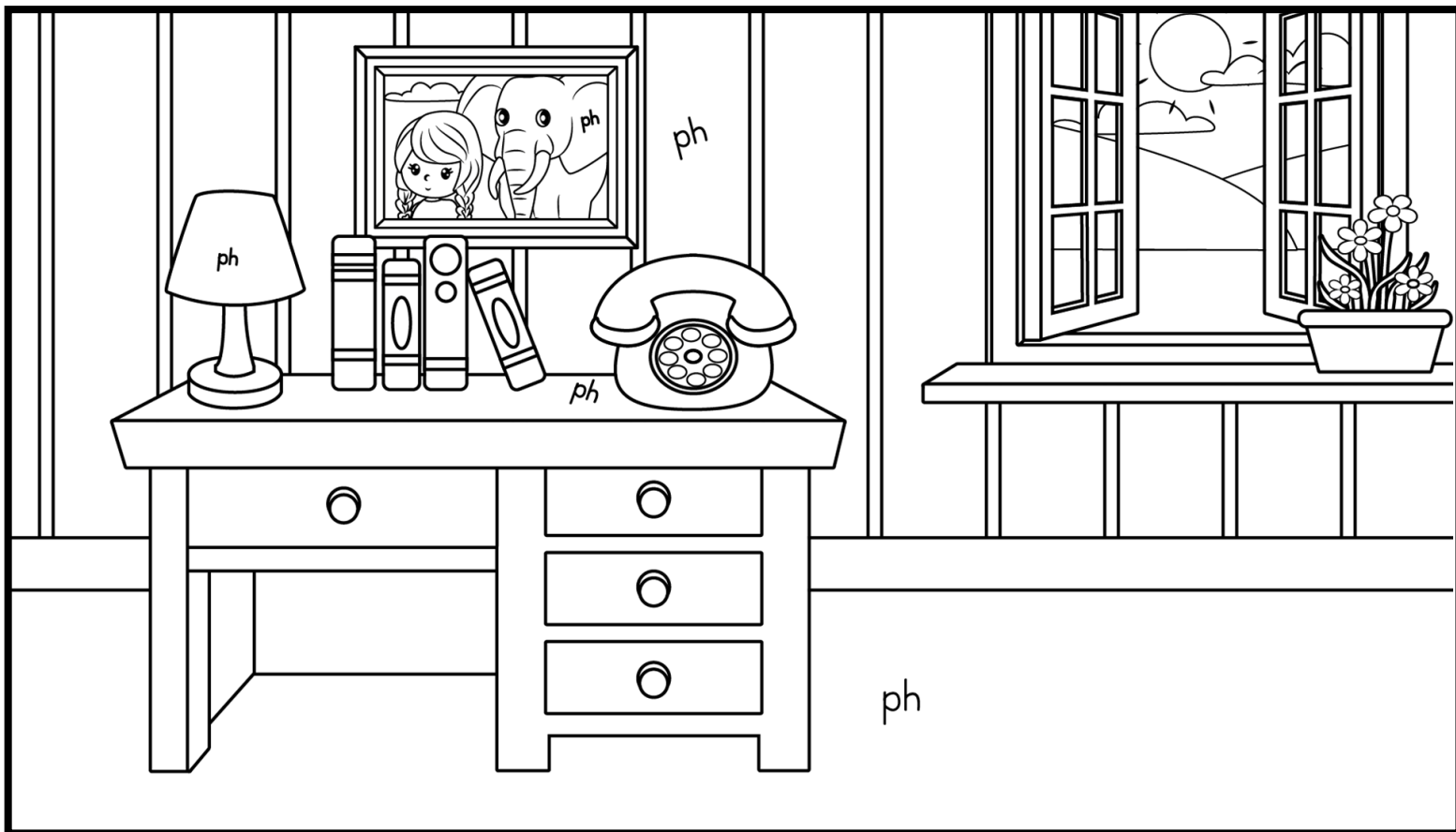

Trace /ph/ words below. Circle all the letter ph's you can find.

gh ch in ph ch
 ph ph in ph gh photo
 eh phone ph in eh ch ch ph
 ch ph ch ph ch fh in ch in ph ch
 ph gh ph ch in ph gh ph ph ph
 ph gh ph in in elephant bh

Phonics

Garden

Name _____

Color all the things with a /ph/ sound. Find the hidden letters.

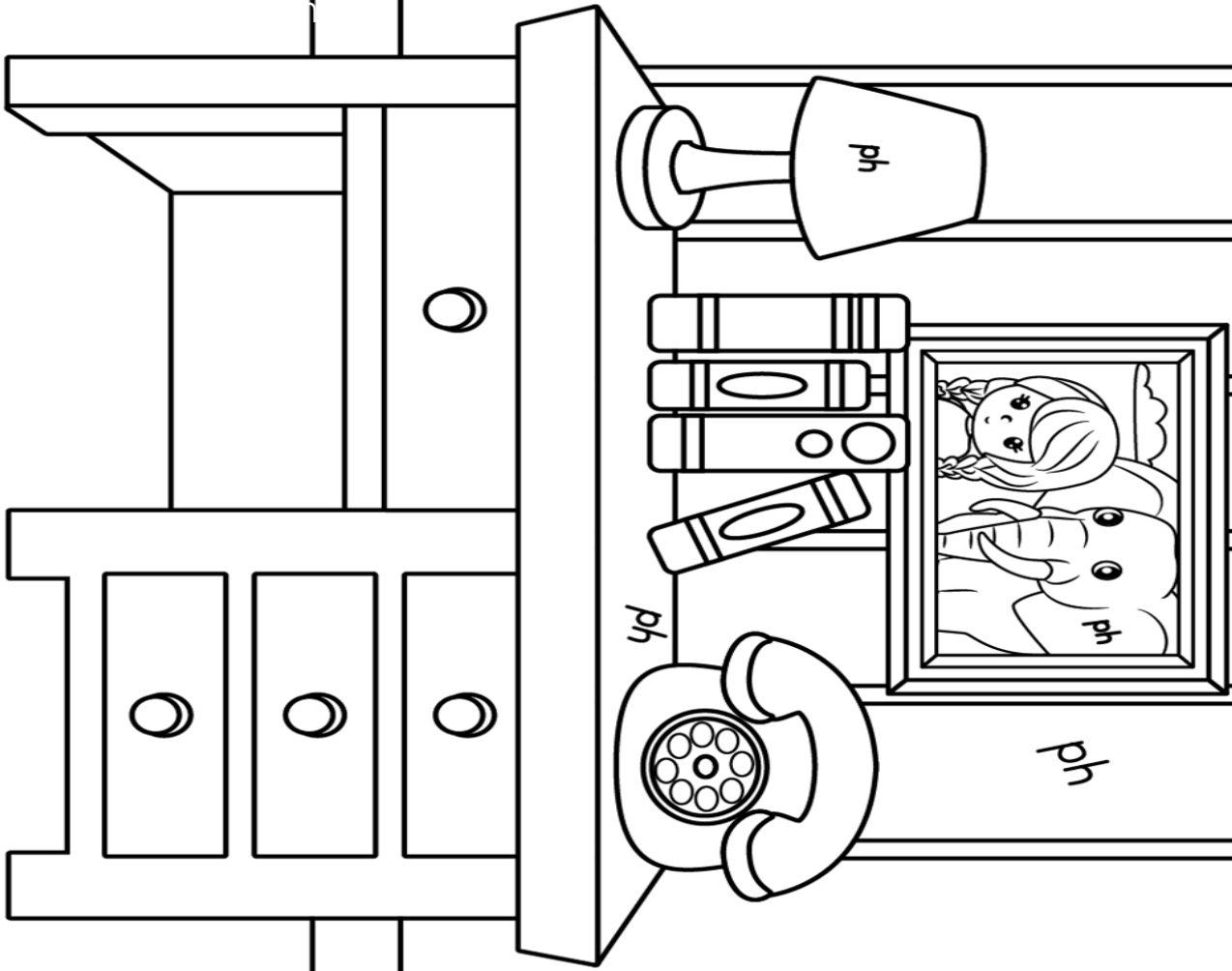

ph